

Speed Reducer Type	C-Face	Max. Output Torque (in-lb)	203
Shaft Orientation	Right Angle	Overhung Load (lb.)	275
NEMA/IEC Frame	56C	Nominal Output RPM	117
Standards	AGMA	Number of Stages	1
Seal Type	Double Lip	Max. Input HP	0.5
Rotation	Forward/Reversible	Nominal Ratio	15:1
Duty	Standard	Input RPM	1750

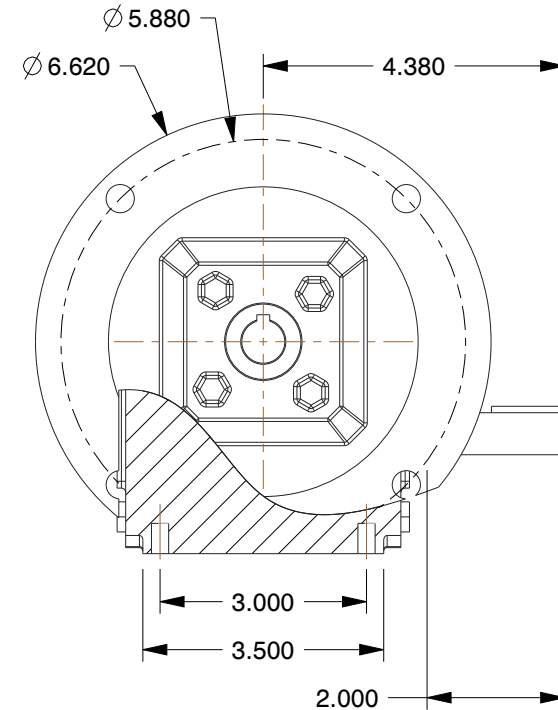
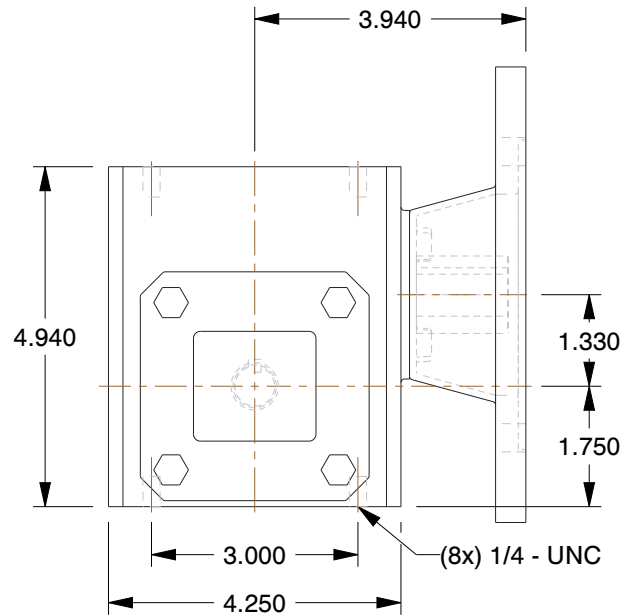
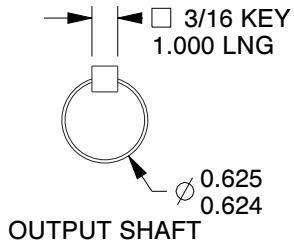

NOTES:

1. BEARINGS: Ball
2. GEAR TYPE: Worm
3. FINISH: Powdered Epoxy Paint
4. HOUSING MATERIAL: Cast Iron
5. WORM GEAR MATERIAL: Bronze
6. PINION MATERIAL: Hardened Steel
7. OUTPUT/SHAFT TYPE: SingleSolid
8. LUBRICATION: Klubersynth UH1 6-540
9. GEAR MATERIAL: Hardened and Ground Steel
10. MOUNTING: Any Position Except Input Motor Shaft Up
11. OUTPUT TORQUE (in.-lb.)
 - @ 1/4 HP 109
 - @ 1/3 HP 147
 - @ 1/2 HP 203

COMPONENT	Speed Reducer
-----------	---------------



100 Grainger Parkway, Lake Forest, Illinois 60045-5201
1-(800) GRAINGER, 1-(800) 472-4643, (847) 535-1000
www.grainger.com

This file and any associated information and specifications are provided for reference and evaluation purposes only, and is subject to change without notice. Grainger makes no representations, warranties or guarantees as to the appropriateness, accuracy, completeness, or suitability for any purpose, of the file, information or specifications. You are solely responsible for the use of the file, information or specifications.

This drawing is the property of GRAINGER. It contains confidential, proprietary information that is GRAINGER property. Do not disclose to or duplicate for others except as authorized by GRAINGER.

SCALE 0.36

4RN76

Speed Reducer, C-Face, 56C, 15:1

UNIT
INCH
SHEET
1 of 1