

Series	FD45,B	Sleeve Material	Steel
Shut Off	Double	Coupler Body Size	3/8"
Seal Type	Captive Valve	Coupler Flow Rate	6.0 gpm
Valve Design	Poppet	Locking Mechanism	Ball
Seal Material	Buna	Coupler Thread Size	3/8"-18
Max. Pressure	4000 psi	Coupler Body Material	Steel

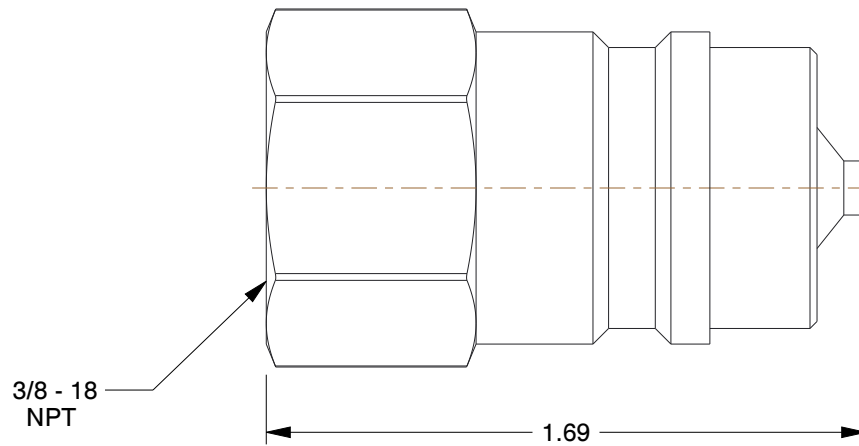
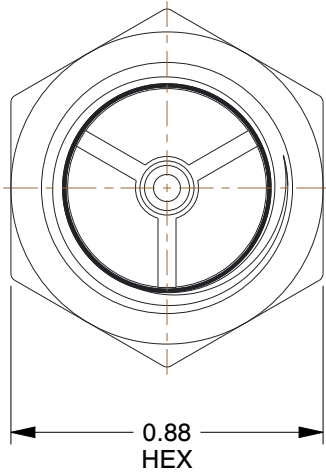

**NOTES:**

1. ITEM: Hydraulic Coupler Nipple
2. STANDARDS: ISO-7241-1 Series B
3. HANSEN INTERCHANGE: 3-K21
4. PARKER INTERCHANGE: H3-63
5. COUPLER CONNECTION TYPE: FNPT
6. COUPLER FINISH: Trivalent Chromium Zinc
7. FOR USE WITH: All Hydraulic Applications
8. OPERATING TEMP. RANGE: -40° to 250°F
9. COUPLER INTERCHANGE TYPE: ISO Series B
10. QUICK COUPLER TYPE: Hydraulic Coupler Nipple

<b>COMPONENT</b>	Hydraulic Quick Couplers
------------------	--------------------------



100 Grainger Parkway, Lake Forest, Illinois 60045-5201  
 1-(800) GRAINGER, 1-(800) 472-4643, (847) 535-1000  
 www.grainger.com

This file and any associated information and specifications are provided for reference and evaluation purposes only, and is subject to change without notice. Grainger makes no representations, warranties or guarantees as to the appropriateness, accuracy, completeness, or suitability for any purpose, of the file, information or specifications. You are solely responsible for the use of the file, information or specifications.

This drawing is the property of GRAINGER. It contains confidential, proprietary information that is GRAINGER property. Do not disclose to or duplicate for others except as authorized by GRAINGER.

**SCALE** 1.85

<h1>2F621</h1> <p>Coupler Nipple, 3/8-18, 3/8 In. Body, Steel</p>	<b>UNIT</b>
	INCH
	<b>SHEET</b>
	1 of 1