

MOUNTING HOLE DETAILS

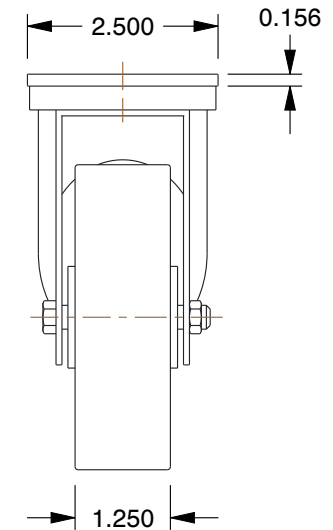
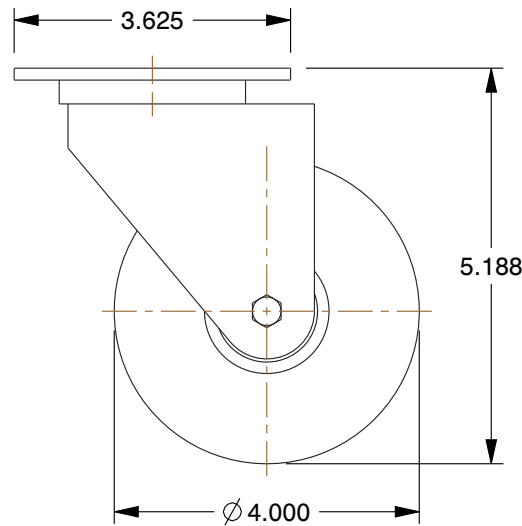
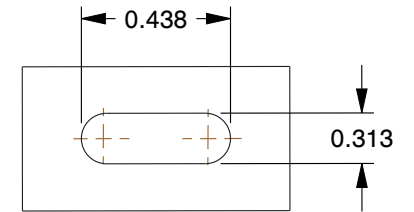

NOTES:

1. LOAD RATING : 350 lb.
2. WHEEL COLOR : Gray
3. FRAME FINISH : Zinc Plated
4. CASTER WHEEL BEARINGS : Ball
5. CASTER FRAME MATERIAL : Steel
6. CASTER WHEEL SHAPE : Standard
7. CASTER CORE MATERIAL : Polyolefin
8. CASTER WHEEL/TREAD MATERIAL : Polyurethane
9. CASTER LOAD RATING RANGE : Light-Medium Duty
10. CASTER SUB TYPE : Swivel

COMPONENT	Plate Caster
1UHZ7	UNIT
Swivel Plate Caster, Polyurethane, 4 in, 350 lb	INCH
	SHEET
	1 of 1



100 Grainger Parkway, Lake Forest, Illinois 60045-5201
 1-(800) GRAINGER, 1-(800) 472-4643, (847) 535-1000
 www.grainger.com

This file and any associated information and specifications are provided for reference and evaluation purposes only, and is subject to change without notice. Grainger makes no representations, warranties or guarantees as to the appropriateness, accuracy, completeness, or suitability for any purpose, of the file, information or specifications. You are solely responsible for the use of the file, information or specifications.

This drawing is the property of GRAINGER. It contains confidential, proprietary information that is GRAINGER property. Do not disclose to or duplicate for others except as authorized by GRAINGER.

SCALE 0.40