

Switches, Single Pole
15A, 120-277V AC

Style Line® Decorator Series Specification Grade Switch

HUBBELL

Features

- Thread cleaning captive mounting screw
- Steel, zinc plated bridge is corrosion resistant
- Automatic self-grounding staple

Ordering Information

Description	Rocker Color	UPC	Catalog Number
Rocker, back and side wired	White	783585108315	DS115W

Listings

UL Listed
CSA Certified

Specifications

Rocker Material	Thermoplastic
Contacts	Silver Alloy
Terminal Screws	Brass
Mounting Bridge	Nickel Plated Steel with Auto Ground Staple
Contacts	Silver Alloy
Ground Screw	Brass (Green)

Performance

Electrical

Dielectric Voltage	Withstands 1500V AC minimum for 1 minute
Max. Continuous Current	15A
Max. Working Voltage	277V AC
Overload	Minimum 4.8 times rated current for 100 cycles
Temperature Rise	30°C maximum at rated current

Mechanical

Terminal Accommodations #14 AWG min. - #10 AWG max. solid and stranded copper wire only

Environmental

Flammability	UL 94V-2
Operating Temperature	Max. continuous: 75°C; Min. continuous: -40°C without impact

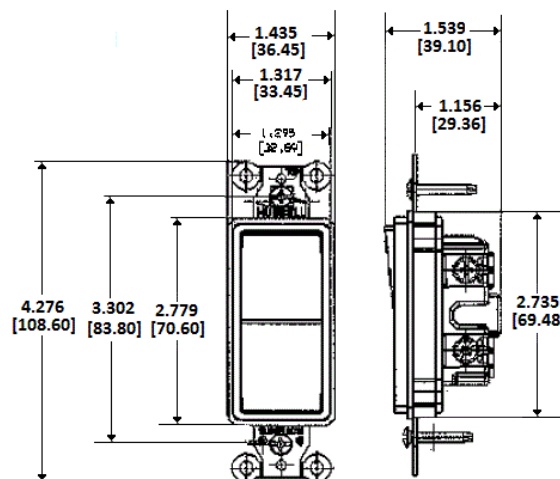

Online Resources

Customer Use Drawing
eCatalog
Installation Instructions

Dimensions in Inches (mm)

Hubbell Wiring Device-Kellems • Hubbell Incorporated (Delaware) • 40 Waterview Drive • Shelton, CT 06484

Phone (800) 288-6000 • Fax (800) 255-1031 • Specifications subject to change without notice.

