

IEC Pin and Sleeve
Accessories
Back Box

HUBBELL

Ordering Information

Description	Device Color	UPC	Catalog Number
Feed-thru box for 16, 20, 30 and 32A devices	Gray	78358575025	FT302W



Specifications

Accessory Item	Cast Aluminum Back Box
----------------	------------------------

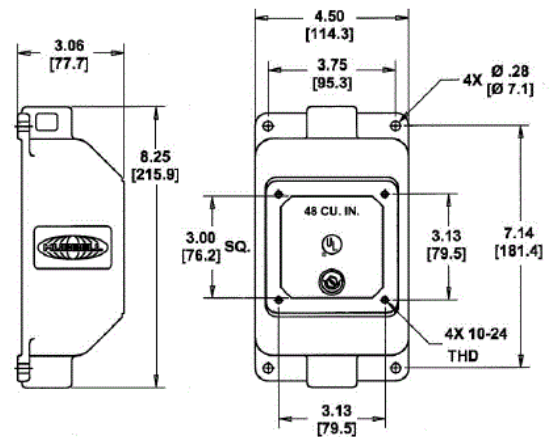

Accessories

Receptacle/Inlet Accommodation 16A, 20A, 30A & 32A IEC Pin & Sleeve
Receptacle/Inlet Accommodation Watertight Safety-Shroud®

Resources

Customer Use Drawing
eCatalog

Dimensions in Inches (mm)

Hubbell Wiring Device-Kellems • Hubbell Incorporated (Delaware) • 40 Waterview Drive • Shelton, CT 06484

Phone (800) 288-6000 • Fax (800) 255-1031 • Specifications subject to change without notice.

