

# The proof

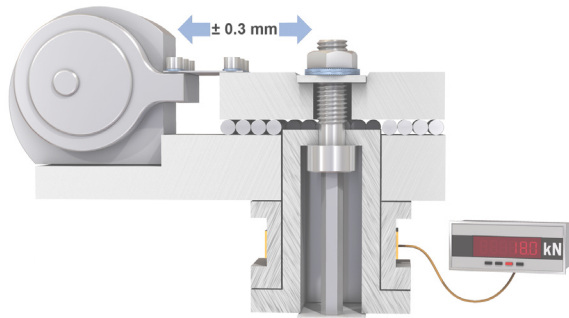

The Junker vibration test to DIN 65151 is an excellent method for testing and comparing the security of bolted joints. During the test, the joint is subjected to transverse movements while the tension is being continuously measured by a load cell.

The Junker test shows that Nord-Lock washers safely secured the bolted connection; only a limited amount of tension is initially lost due to normal settlements. The wedge-locking function is verified through the clear increase in tension during untightening. All other bolt locking methods in the test failed to prevent loosening of the joint.

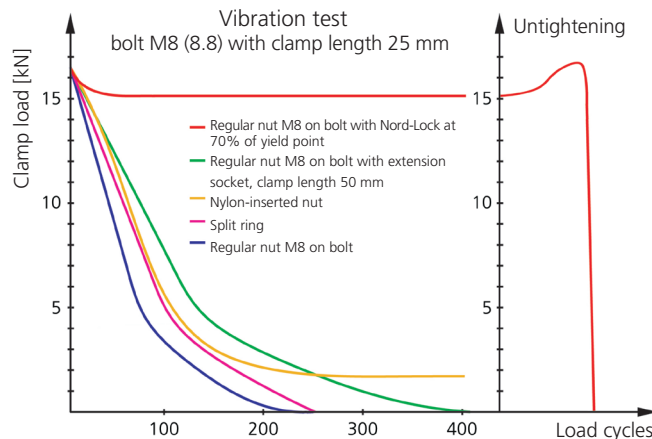

Nord-Lock washers are available with enlarged outer diameter in order to increase the load supporting area.

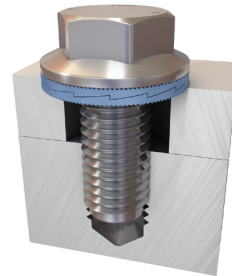

For slotted holes or on soft material, use a flanged nut/ bolt in combination with Nord-Lock "sp" (enlarged outer diameter) washers.

**Proven and certified by TÜV**  
Nord-Lock washers have been certified for safety and quality by TÜV, a leading international institute in quality and safety certification.



## Where is Nord-Lock used?

Energy • Construction • Off Road  
Agriculture • Marine • Trucking • Mining  
Offshore • Railroad • Power Plants  
Manufacturing • Processing • Utilities

**NORD-LOCK®**  
Bolt securing systems

**Nord-Lock Group**  
Tel: 877-799-1097 • [bolting@nord-lock.com](mailto:bolting@nord-lock.com)  
[www.nord-lock.com](http://www.nord-lock.com)

© Copyright 2016 Nord-Lock Group. NORD-LOCK, SUPERBOLT and BOLTIGHT are trademarks owned by different companies within the Nord-Lock Group. All other logos, trademarks, registered trademarks or service marks used herein are the property of the Nord-Lock Group. All rights reserved.

# Nord-Lock washers

For your critical bolting applications



English • Revised but not printed • 2016-02 • 70007EN



**NORD-LOCK®**

## Exceptional value

**Nord-Lock offers a safe bolt locking system that does not rely on traditional techniques to secure the fastener. This system utilizes tension instead of friction to secure bolted joints. The proven wedge-locking method, meeting DIN 25201, is superior to any traditional method.**

The system is comprised of a pair of washers that has cams on one side and radial teeth on the opposite side. Since the cam angle " $\alpha$ " is greater than the thread pitch " $\beta$ " a wedge effect is created by the cams, preventing the bolt from rotating loose.

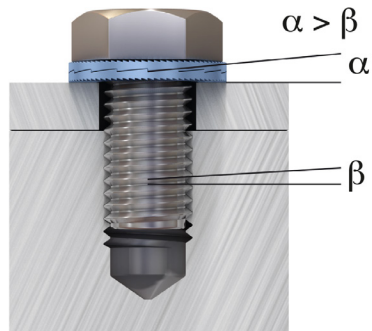

Nord-Lock washers are rigorously tested in all steps of production to verify that the quality requirements are met. Over the complete life cycle, Nord-Lock washers give increased operational reliability and lower maintenance costs while significantly reducing the risks of production stops, accidents and warranty claims.

## Advantages

- Prevents loosening caused by vibration and dynamic loads
- Easy assembly and disassembly
- Locking function not affected by lubrication
- No special tools required
- Controllable preload
- Same temperature characteristics as bolt / nut of corresponding quality
- Reusable

Each batch of Nord-Lock washers is assigned a control number which ensures full traceability down to full assembly.



Significant range and variety:

- Steel, zinc flake coated with Delta Protekt®, M3 – M130 / #5 – 5"
- Stainless steel, M3 – M80 / #5 – 3 1/8"
- 254 SMO®, M3 – M39 / #5 – 1 1/2"
- Special alloys for high temperatures or highly corrosive environments (upon request)

## Assembly examples

Nord-Lock washers can be used with standard and high grade bolts.

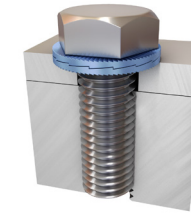

*Nord-Lock washers for tapped holes.*

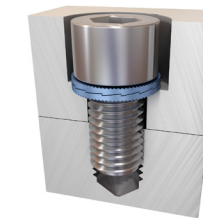

*Nord-Lock washers are sized for counter-bored holes.*

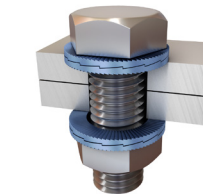

*Through holes require two pairs of Nord-Lock washers.*



*For stud bolts Nord-Lock washers lock the nut, and eliminate the need for adhesives.*



*Nord-Lock washers must not be used on washers that are not captivated in place.*